

# Infinite System Specification

## — X Shape



ME3535D-X  
ME5035D-X  
ME7035D-X  
ME3535P-X  
ME5035P-X  
ME7035P-X



90°



120°

Optical: Diffuser



90°



120°

Optical: Prismatic

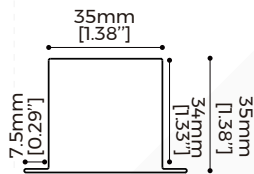

Model:  
ME3535D-X  
ME3535P-X

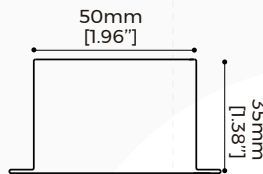

Model:  
ME5035D-X  
ME5035P-X

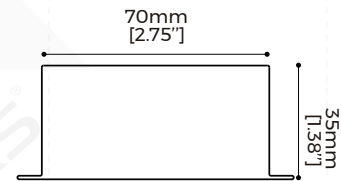

Model:  
ME7035D-X  
ME7035P-X

## Basic Information

### Light efficiency

<b>ME3535D-X</b> 100LM/W(Regular), 120LM/W(High-Efficiency)	<b>ME3535P-X</b> 85LM/W(Regular), 105LM/W(High-Efficiency)
<b>ME5035D-X</b> 100LM/W(Regular), 120LM/W(High-Efficiency)	<b>ME5035P-X</b> 90LM/W(Regular), 105LM/W(High-Efficiency)
<b>ME7035D-X</b> 110LM/W(Regular), 135LM/W(High-Efficiency)	<b>ME7035P-X</b> 100LM/W(Regular), 120LM/W(High-Efficiency)

### Common information

· Material:	AL6063-T5, spraying surface
· Color:	Black/White/Silver/Orange/Blue/Green /Rose gold/Champagne gold
· Length:	300mm
· Corner angle:	90°/120°
· IP grade:	IP20
· CCT:	2700/3000/3500/4000/5000/6500K optional
· CRI:	>80/>90
· SDCM:	≤3 Step
· Dimming method:	Non-dimming, 1-10V, DALI2+PUSH
· Application:	Indoor
· Installation:	Recessed
· Certification:	CE, UKCA, ROHS, REACH, CB, ENEC, ETL, LM-80
· Warranty:	5 years

© Product Dimension Information

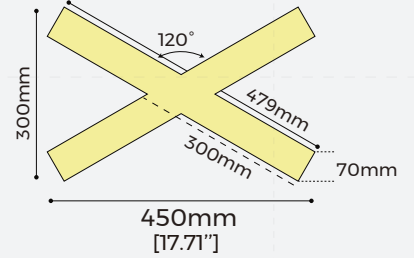
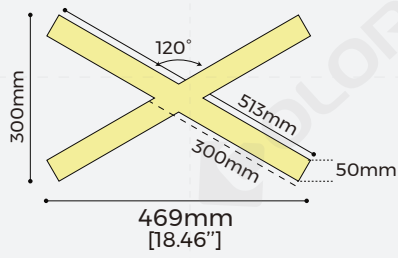
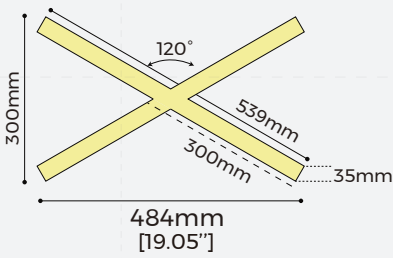
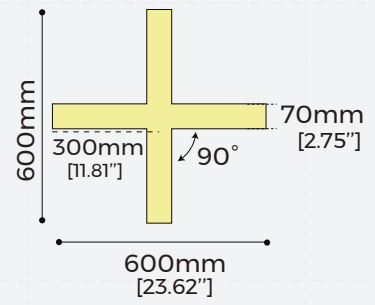
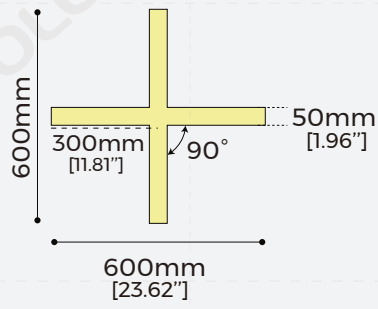
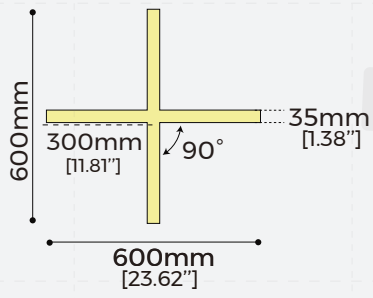

\*The yellow fill means luminous surface.

© Luminaire Parameters

Model	Version	Length (mm)	Angle (°)	Type Power (W/PCS)	Input Voltage (V)	Input Current (A)	CRI	Lumens (LM/PCS)	CCT
ME3535D-X	Regular	300 [0.98ft]	90°	24	DC36V	0.6	>80	2372	2700K 3000K 3500K 4000K 5000K 6500K
							>90	2040	
		300 [0.98ft]	120°	21	DC36V	0.53	>80	2076	
							>90	1785	
	High-Efficiency	300 [0.98ft]	90°	24	DC36V	0.6	>80	2847	
							>90	2448	
		300 [0.98ft]	120°	21	DC36V	0.53	>80	2491	
							>90	2142	
ME3535P-X	Regular	300 [0.98ft]	90°	24	DC36V	0.6	>80	2016	
							>90	1734	
		300 [0.98ft]	120°	21	DC36V	0.53	>80	1764	
							>90	1517	
	High-Efficiency	300 [0.98ft]	90°	24	DC36V	0.6	>80	2491	
							>90	2142	
		300 [0.98ft]	120°	21	DC36V	0.53	>80	2179	
							>90	1874	
ME5035D-X	Regular	300 [0.98ft]	90°	30	DC36V	0.75	>80	2965	
							>90	2550	
		300 [0.98ft]	120°	24	DC36V	0.61	>80	2412	
							>90	2074	
	High-Efficiency	300 [0.98ft]	90°	30	DC36V	0.75	>80	3558	
							>90	3060	
		300 [0.98ft]	120°	24	DC36V	0.61	>80	2894	
							>90	2489	
ME5035P-X	Regular	300 [0.98ft]	90°	30	DC36V	0.75	>80	2669	
							>90	2295	
		300 [0.98ft]	120°	24	DC36V	0.61	>80	2170	
							>90	1867	
	High-Efficiency	300 [0.98ft]	90°	30	DC36V	0.75	>80	3113	
							>90	2678	
		300 [0.98ft]	120°	24	DC36V	0.61	>80	2532	
							>90	2178	

Model	Version	Length (mm)	Angle (°)	Type Power (W/PCS)	Input Voltage (V)	Input Current (A)	CRI	Lumens (LM/PCS)	CCT
ME7035D-X	Regular	300 [0.98ft]	90°	40	DC36V	1	>80	4349	2700K 3000K 3500K 4000K 5000K 6500K
							>90	3740	
		300 [0.98ft]	120°	28	DC36V	0.72	>80	3131	
							>90	2693	
	High-Efficiency	300 [0.98ft]	90°	40	DC36V	1	>80	5337	
							>90	4590	
		300 [0.98ft]	120°	28	DC36V	0.72	>80	3843	
							>90	3305	
ME7035P-X	Regular	300 [0.98ft]	90°	40	DC36V	1	>80	3953	
							>90	3400	
		300 [0.98ft]	120°	28	DC36V	0.72	>80	2847	
							>90	2448	
	High-Efficiency	300 [0.98ft]	90°	40	DC36V	1	>80	4744	
							>90	4080	
		300 [0.98ft]	120°	28	DC36V	0.72	>80	3416	
							>90	2938	

Note:

1. The output data is based on white coated luminaire with Ra80,4000K.
2. The above Lumens data are at 4000K color temperature.
3. High-efficiency version does not do 3500K and 5000K.
4. The tolerance of output data can be vary up to 15%.
5. The type power is with the power supply, the input current is the current of the light source.
6. The output data is typical value.
7. The following is an example of lumen conversion instructions:

CCT	RA	Ratio of lumens (white coated luminaire)	Ratio of lumens (Other coated colors of luminaire)
2700K	80	90%	Calculate white coated luminaire lumens first, then multiply by 90 %
	90	77%	
3000K	80	93%	
	90	80%	
3500K	80	97%	
	90	83%	
4000K	80	100%	
	90	86%	
5000K	80	100%	
	90	86%	
6500K	80	100%	
	90	86%	

Note: All other lumens are to be based on white coated luminaire with 4000K, RA80(100%); and multiplied by the percentage in the table above.

**Assuming a 4000K, RA80 white coated luminaire with 1000lm lumens:**

Example 1: If you need 4000K, RA90 lumens (white coated luminaire)	$1000 \times 86\% = 860\text{lm}$
Example 2: If you need 4000K, RA90 lumens (other coated colors of luminaire)	$1000 \times 86\% \times 90\% = 774\text{lm}$
Example 3: If you need 3000K, RA80 lumens (white coated luminaire)	$1000 \times 93\% = 930\text{lm}$
Example 4: If you need 3000K, RA90 lumens (white coated luminaire)	$1000 \times 80\% = 800\text{lm}$
Example 5: If you need 5000K, RA80 lumens (white coated luminaire)	$1000 \times 100\% = 1000\text{lm}$

## © Optical Parameter

### 【ME3535D-X】

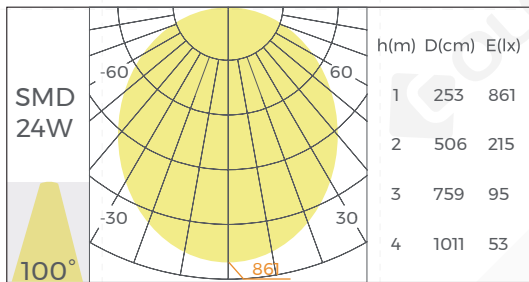

Regular version

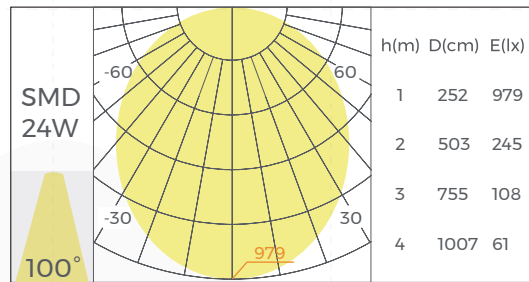

High-efficiency version

\*The above data is based on a 90° corner angle, 300mm length module with Ra80,4000K.

### 【ME3535P-X】

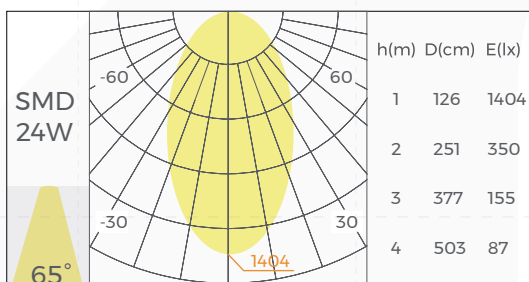

Regular version

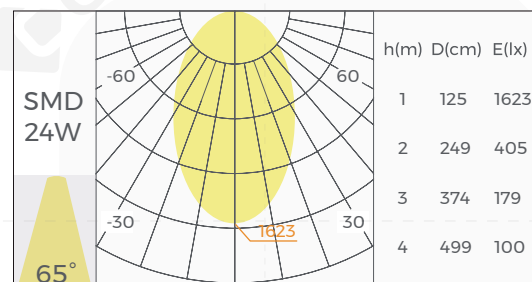

High-efficiency version

\*The above data is based on a 90° corner angle, 300mm length module with Ra80,4000K.

### 【ME5035D-X】

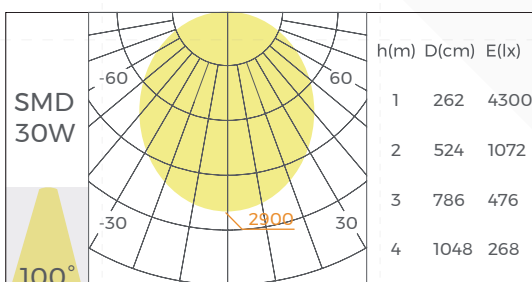

Regular version

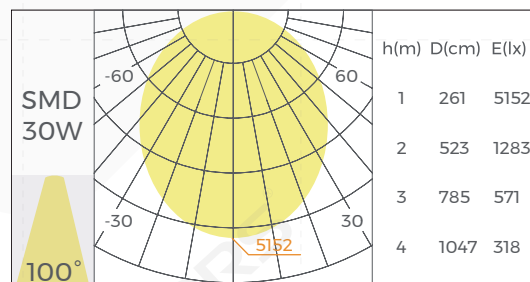

High-efficiency version

\*The above data is based on a 90° corner angle, 300mm length module with Ra80,4000K.

**【ME5035P-X】**

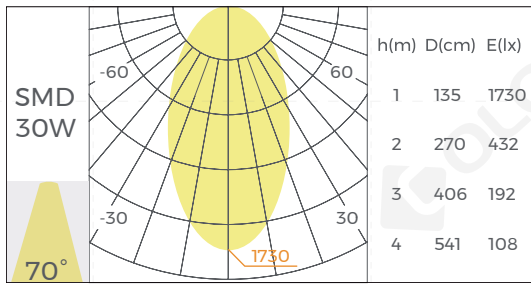

Regular version

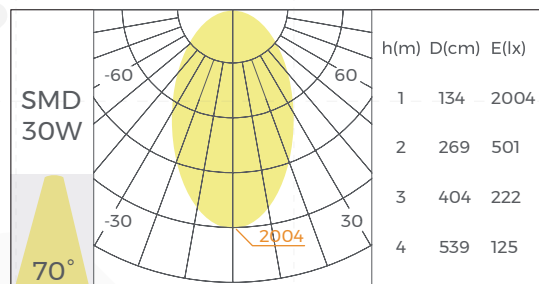

High-efficiency version

\*The above data is based on a 90° corner angle, 300mm length module with Ra80,4000K.

**【ME7035D-X】**

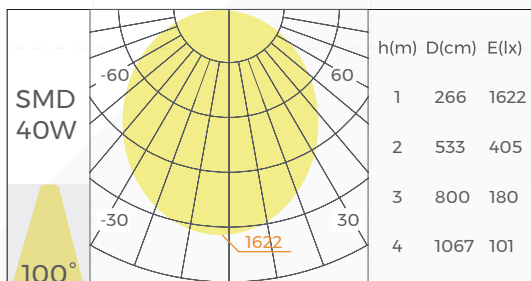

Regular version

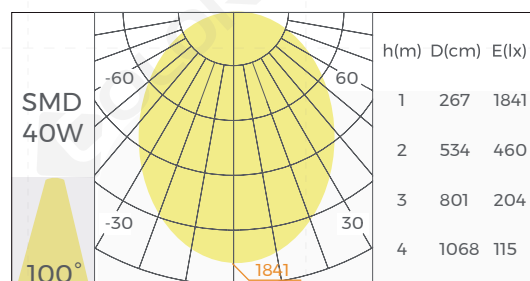

High-efficiency version

\*The above data is based on a 90° corner angle, 300mm length module with Ra80,4000K.

**【ME7035P-X】**

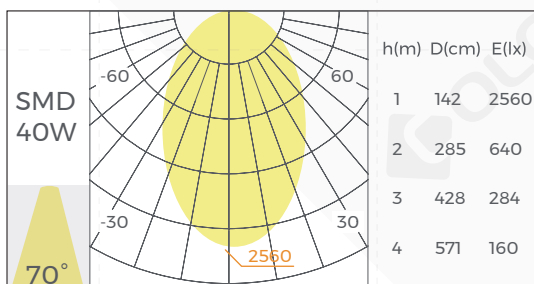

Regular version

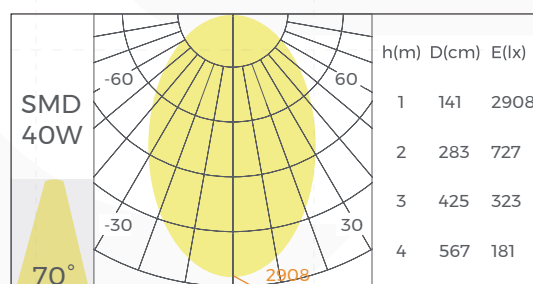

High-efficiency version













\*The above data is based on a 90° corner angle, 300mm length module with Ra80,4000K.

Note:

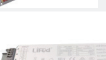
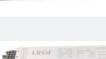
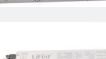
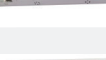

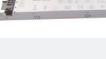
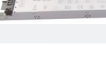
1. The above optical parameters refer to the Line series; only the light-emitting angle can be used as a reference.
2. For specific luminous effects, please use the report input DIALux software in the test report.

## Common Accessories

### Power supply

Picture	Dimming Method	Model	Input Voltage	Output Voltage	Output Current	Size(mm)	Certification
	NO/OFF	LF-GMR020YS0350H(S)	AC220 ~240V 50/60Hz	20-56V	0.2-0.35A	168*30*21	CCC/ENEC/CE/ RCM/UKCA
		LF-GMR040YS0700H(S)		20-56V	0.35-0.7A	210*30*21	
		LF-GMR040YS1050H(S)		20-38V	0.7-1.05A	210*30*21	
		LF-GMR060YS1550H(S)		20-39V	1.2-1.55A	280*30*21	
		LF-GMR060YS II		33-42V	1.15A	245*30*21	
		LF-GMR080YS II		33-42V	1.6/1.7/1.8 /1.9/2A	245*30*21	
	0-10V	LF-GLD025YE	AC220 ~240V 50/60Hz	25-42V	0.3/0.35/0.4 /0.45/0.5/0.55A	245*30*21	CCC/ENEC/CE/ RCM/UKCA
		LF-GLD035YE		25-42V	0.6/0.65/0.7 /0.75/0.8A	245*30*21	
		LF-GLD045YE		25-42V	0.85/0.9/1 /1.05A	245*30*21	
		LF-GLD055YE		25-42V	1.1/1.15/1.2 /1.3A	285*30*21	
		LF-GLD065YE		25-42V	1.35/1.4/1.5 /1.55A	285*30*21	
		LF-GLD080YE		25-40V	1.6/1.7/1.8/1.9/2A	355*30*21	
		LF-GSD020YE		25-42V	0.25-0.5A (50mA)	245*30*21	
		LF-GSD030YE		25-42V	0.55-0.75A (50mA)	245*30*21	
	DALI	LF-GSD040YE	AC220 ~240V 50/60Hz	25-42V	0.8-1.05A (50mA)	245*30*21	CCC/ENEC/CE/ RCM/UKCA
		LF-GSD060YE		25-42V	1.1-1.5A (50mA)	285*30*21	
		LF-GSD080YE		25-42V	1.55-2.0A (50mA)	355*30*21	

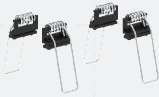
## Installation accessories

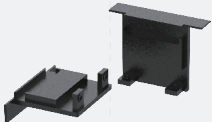
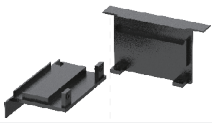
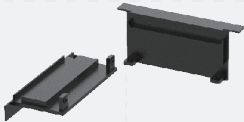
Picture	Name	Model	Description
	Recessed	RB-04	Suitable for ME3535/ME5035/ME7035 recessed accessory 4 pcs/set
	Input line	CM-24	Wire Size: D3*2000mm Maximum current capacity: 4A Maximum weight capacity: 8Kg Suitable for MS3570/MS5070/MS7070/MS3535/MS5035/ MS7035 ceiling and ME3535/ME5035/ME7035 recessed input line
	End Caps	EC-ME3535	Material:AL6063-T5 Size:L50*W35*H2.5mm
	End Caps	EC-ME5035	Material:AL6063-T5 Size:L65*W35*H2.5mm
	End Caps	EC-ME7035	Material:AL6063-T5 Size:L85*W35*H2.5mm

- Note:
1. The modules are manufactured with splicing accessories and terminals.
  2. All standard modules can only use the power supply external solution, the above installation accessories for power supply external.

# Non-Directional Terminal Design

Non-directional terminal design that simplifies and enhances the efficiency of electrical connections between modules.

② Select Power Supply

**Drive**  
Output: 2A & 1.5A

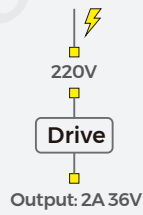

③ Power Taking & Wiring Diagram

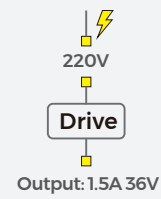

MAX CURRENT: 2A

The total current of the design should be consistent with the output current of the power supply

AC 220V



Non-directional

Note:

1. The above electrical connection modeling is a 35mm luminaire height demonstration only to show the non-directional terminal design.
2. The above graphic explains how to select the right power supply by calculating the current

## ◎ Packing

Model	Quantity (PCS/carton)	NW (kg/carton)	GW (kg/carton)	Size (mm/carton)
ME3535D0300X90(R) -X840W024	4	3.94	7.20	700*430*380 [27.55"*16.92"*14.96"]
ME5035D0300X90(R) -X840W030	4	4.80	8.00	700*430*380 [27.55"*16.92"*14.96"]
ME7035D0300X90(R) -X840W040	4	5.76	9.20	700*430*380 [27.55"*16.92"*14.96"]
ME3535D0300X120(R) -X840W021	4	3.94	7.20	700*430*380 [27.55"*16.92"*14.96"]
ME5035D0300X120(R) -X840W024	4	4.80	8.00	700*430*380 [27.55"*16.92"*14.96"]
ME7035D0300X120(R) -X840W028	4	5.76	9.20	700*430*380 [27.55"*16.92"*14.96"]

- Note:
1. Modules packaged without inner box, directly use the outer box.
  2. Use one outer box for each module, and then use the wrap and corner protectors to tie them together according to the quantity of carton above.
  3. The above weight data is for reference, the exact data should be based on the weight of the physical weighing shall prevail.

## ◎ Model Code

<b>M</b>	<b>E</b>	<b>3535</b>	<b>D</b>	<b>0300</b>	<b>X90</b>	<b>(R)</b>	-	<b>X</b>	<b>8</b>	<b>40</b>	<b>B</b>	-	<b>024</b>
Type M: Module	Installation E: Recessed S: Ceiling/Pendant	Size 3535: 35mm: Surface width of module 35mm: Height of module	Optical Type D: Diffuser P: Prismatic	Length 0300: 300mm	Corner Angle X90: X shape, 90°	Version (R): Regular (H): High-efficiency		Dimming Method X: No power N: Non-dimming D: 1-10V A: DALI	CRI 8: Ra>80 9: Ra>90	CCT 27: 2700K 30: 3000K 40: 4000K	Color B: Black W: White S: Silver		Type power 024: 24W

## ◎ Attentions

1. Non-professionals are prohibited from installing, disassembling and repairing the product.
2. Avoid scratching, distortion and irregular bending of the product during installation; otherwise it may cause irreparable damage to the product.
3. Please use professional cutting tools when cutting
4. Do not use any acid or alkaline adhesive to fix products
5. The product is only suitable for indoor dry places, can not be used in outdoor, seaside or wet environment.
6. PC features: Each 10°C rise or drop will make diffuser extend or shrink 0.8mm/m, please confirm before processing and use